

**Sensing range**  
5 mm

Inductive sensor

- Short-circuit protection (pulsed)
- Robust brass housing, nickel-plated with fine thread M18 x 1 mm
- Enclosure rating IP 67
- Installation flush

Dimensional drawing

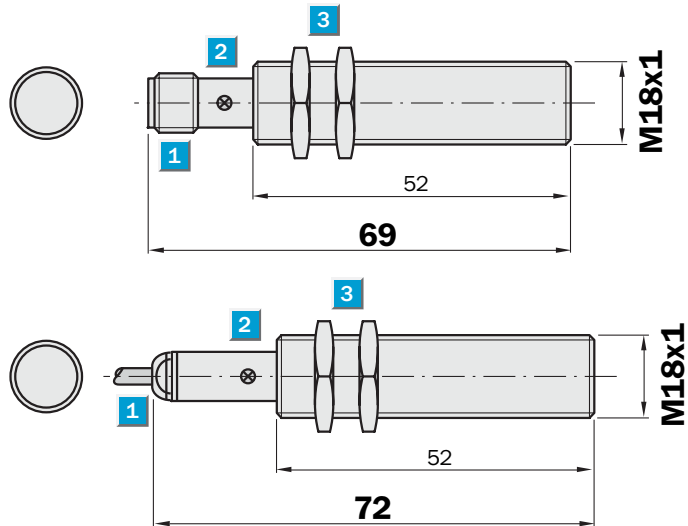

- 1 Connection
- 2 Display LED
- 3 Fastening nuts (2 x); width across 24, metal

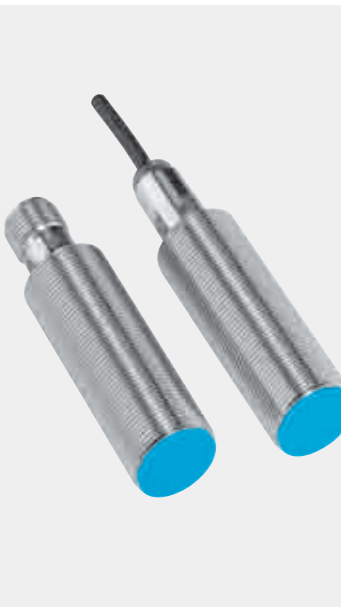

Connection type

IME18-05BNOZC0S	IME18-05BNOZW2S	IME18-05BNSZC0S
IME18-05BPSZC0S	IME18-05BNSZW2S	IME18-05BPSZ0S
	IME18-05BPOZW2S	
	IME18-05BPSZW2S	

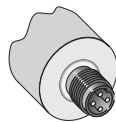

M12, 4-pin

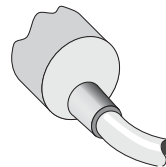
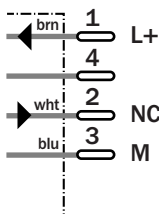

3 x 0.25 mm<sup>2</sup>

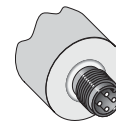
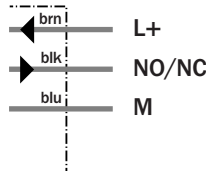

M12, 4-pin

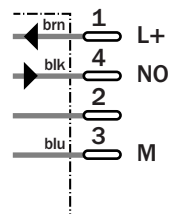

**Accessories**

Connector, M12, 4-pin

Mounting systems

Technical specifications		IME18-	05BNO ZC0S	05BNO ZW2S	05BNS ZC0S	05BNS ZW2S	05BPS ZC0S	05BPO ZW2S	05BPS Z0S	05BPS ZW2S		
<b>Sensing range <math>S_n</math></b>	5 mm											
<b>Electrical configuration</b>	DC 3-wire											
<b>Supply voltage <math>V_s</math></b>	DC 10 ... 30 V											
Nominal voltage $V_n$	DC											
Ripple $U_{pp}$	≤ 10 %											
Voltage drop $U_d$	≤ 2 V <sup>1)</sup>											
Power consumption	≤ 10 mA <sup>2)</sup>											
<b>Continuous current <math>I_a</math></b>	≤ 200 mA											
Time delay before availability $t_v$	≤ 100 ms											
Hysteresis H, of $s_r$	5 ... 15 %											
Repeatability R	≤ 2 % ( $U_b$ and $T_a$ constant) <sup>3)</sup>											
Temperature drift, of $s_r$	± 10 %											
EMC	According to EN 60947-5-2											
<b>Switching output</b>	NPN											
	PNP											
<b>Output function</b>	Normally closed											
	Normally open											
<b>Installation</b>	Flush											
<b>Connection type</b>	Connector, M12, 4-pin											
	Cable, PVC, 2 m											
<b>Enclosure rating</b>	IP 67 <sup>4)</sup>											
Max. switching frequency	300 Hz											
Dimensions	M18 x 1 <sup>5)</sup>											
<b>Short-circuit protection</b>	✓ <sup>6)</sup>											
<b>Reverse polarity protection</b>	✓											
<b>Power-up pulse suppression</b>	✓											
Shock/vibration stress	30 g, 11 ms/10 ... 55 Hz, 1 mm											
Ambient temperature $T_a$	-20 °C ... +65 °C											
<b>Housing material</b>	Brass nickel-plated, plastic											
Tightening torque	40 Nm											

<sup>1)</sup> at  $I_a$  max  
<sup>2)</sup> without load

<sup>3)</sup> of  $s_r$   
<sup>4)</sup> according to EN 60529

<sup>5)</sup> Thread diameter x pitch (mm)  
<sup>6)</sup> (pulsed)

**Reduction factor  $R_M$**

The following are reference values, which may vary from type to type:

St37 (Fe)	1
Stainless steel (V2A)	Approx. 0.8
Aluminum (solid)	Approx. 0.45
Copper (Cu)	Approx. 0.4

**Ordering information**

Type	Part Number
IME18-05BNOZC0S	1 040 946
IME18-05BNOZW2S	1 040 948
IME18-05BNSZC0S	1 040 942
IME18-05BNSZW2S	1 040 944
IME18-05BPSZC0S	1 040 938
IME18-05BPOZW2S	1 040 940
IME18-05BPSZ0S	1 040 934
IME18-05BPSZW2S	1 040 936

**Sensing range**  
8 mm

Inductive sensor

- Short-circuit protection (pulsed)
- Robust brass housing, nickel-plated with fine thread M18 x 1 mm
- Enclosure rating IP 67
- Installation non-flush

Dimensional drawing

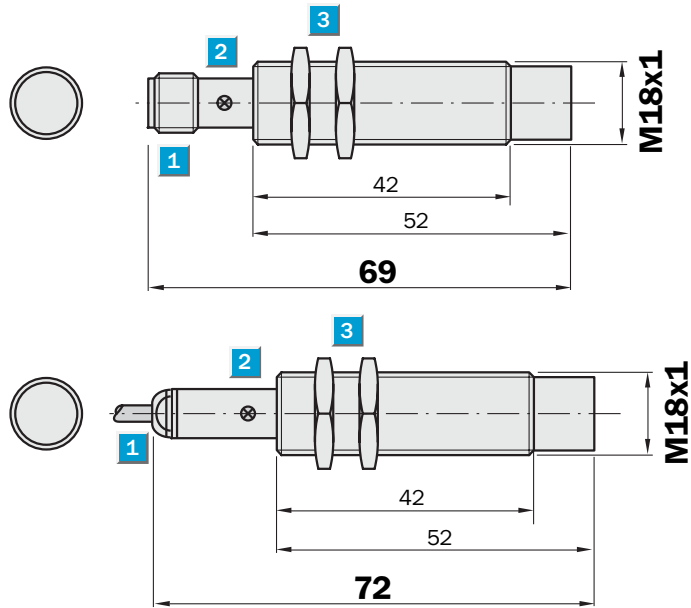

- 1 Connection
- 2 Display LED
- 3 Fastening nuts (2 x); width across 24, metal



Connection type

IME18-08NNOZC0S	IME18-08NNOZW2S	IME18-08NNSZC0S
IME18-08NPOZC0S	IME18-08NNSZW2S	IME18-08NPSZC0S
	IME18-08NPOZW2S	
	IME18-08NPSZW2S	

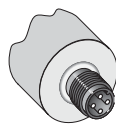

M12, 4-pin

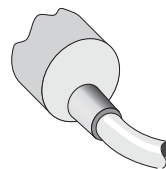
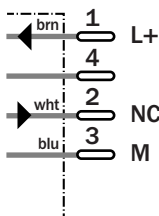

3 x 0.25 mm<sup>2</sup>

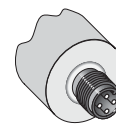
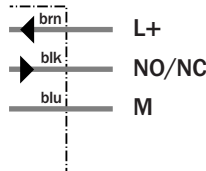

M12, 4-pin

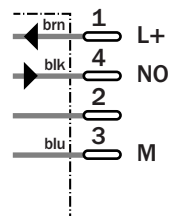

**Accessories**

Connector, M12, 4-pin

Mounting systems

Technical specifications		IME18-	08NN OZC0S	08NNO ZW2S	08NNS ZC0S	08NNS ZW2S	08NPO ZC0S	08NPO ZW2S	08NPS ZC0S	08NPS ZW2S		
<b>Sensing range <math>S_n</math></b>	8 mm											
<b>Electrical configuration</b>	DC 3-wire											
<b>Supply voltage <math>V_s</math></b>	DC 10 ... 30 V											
Nominal voltage $V_n$	DC											
Ripple $U_{pp}$	≤ 10 %											
Voltage drop $U_d$	≤ 2 V <sup>1)</sup>											
Power consumption	≤ 10 mA <sup>2)</sup>											
<b>Continuous current <math>I_a</math></b>	≤ 200 mA											
Time delay before availability $t_v$	≤ 100 ms											
Hysteresis H, of $s_r$	5 ... 15 %											
Repeatability R	≤ 2 % ( $U_b$ and $T_a$ constant) <sup>3)</sup>											
Temperature drift, of $s_r$	± 10 %											
EMC	According to EN 60947-5-2											
<b>Switching output</b>	NPN											
	PNP											
<b>Output function</b>	Normally closed											
	Normally open											
<b>Installation</b>	Non-flush											
<b>Connection type</b>	Connector, M12, 4-pin											
	Cable, PVC, 2 m											
<b>Enclosure rating</b>	IP 67 <sup>4)</sup>											
Max. switching frequency	300 Hz											
Dimensions	M18 x 1 <sup>5)</sup>											
<b>Short-circuit protection</b>	✓ <sup>6)</sup>											
<b>Reverse polarity protection</b>	✓											
<b>Power-up pulse suppression</b>	✓											
Shock/vibration stress	30 g, 11 ms/10 ... 55 Hz, 1 mm											
Ambient temperature $T_a$	-20 °C ... +65 °C											
<b>Housing material</b>	Brass nickel-plated, plastic											
Tightening torque	40 Nm											

<sup>1)</sup> at  $I_a$  max  
<sup>2)</sup> without load

<sup>3)</sup> of  $s_r$   
<sup>4)</sup> according to EN 60529

<sup>5)</sup> Thread diameter x pitch (mm)  
<sup>6)</sup> (pulsed)

**Reduction factor  $R_M$**

The following are reference values, which may vary from type to type:

St37 (Fe)	1
Stainless steel (V2A)	Approx. 0.8
Aluminum (solid)	Approx. 0.45
Copper (Cu)	Approx. 0.4

**Ordering information**

Type	Part Number
IME18-08NNOZC0S	1 040 962
IME18-08NNOZW2S	1 040 964
IME18-08NNSZC0S	1 040 958
IME18-08NNSZW2S	1 040 960
IME18-08NPOZC0S	1 040 954
IME18-08NPOZW2S	1 040 956
IME18-08NPSZC0S	1 040 950
IME18-08NPSZW2S	1 040 952

**Sensing range**  
5 mm

Inductive sensor

- Short-circuit protection (pulsed)
- Robust brass housing, nickel-plated with fine thread M18 x 1 mm
- Enclosure rating IP 67
- Installation flush

Dimensional drawing

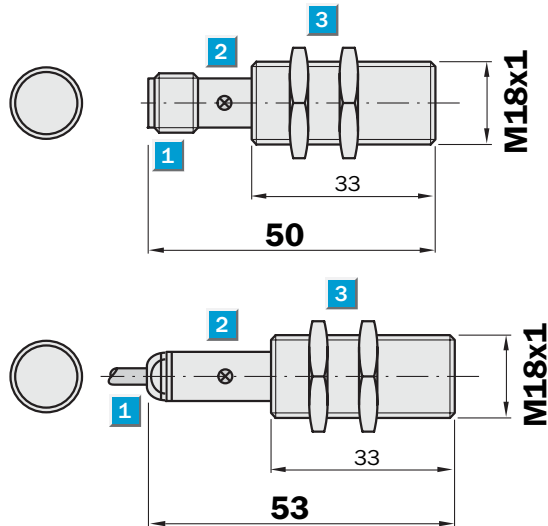

- 1 Connection
- 2 Display LED
- 3 Fastening nuts (2 x); width across 24, metal



Connection type

IME18-05BNOZCOK	IME18-05BNOZW2K	IME18-05BNSZCOK
IME18-05BPOZCOK	IME18-05BNSZW2K	IME18-05BPSZCOK
	IME18-05BPOZW2K	
	IME18-05BPSZW2K	

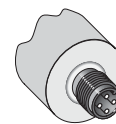
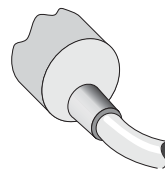
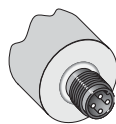

M12, 4-pin

3 x 0.25 mm<sup>2</sup>

M12, 4-pin

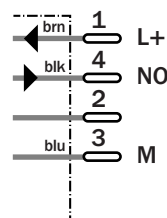
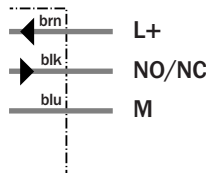
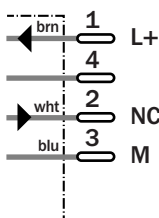

**Accessories**

Connector, M12, 4-pin

Mounting systems

Technical specifications		IME18-	05BNO ZC0K	05BNO ZW2K	05BNS ZC0K	05BNS ZW2K	05BPO ZC0K	05BPO ZW2K	05BPS ZC0K	05BPS ZW2K		
<b>Sensing range <math>S_n</math></b>	5 mm											
<b>Electrical configuration</b>	DC 3-wire											
<b>Supply voltage <math>V_s</math></b>	DC 10 ... 30 V											
Nominal voltage $V_n$	DC											
Ripple $U_{pp}$	≤ 10 %											
Voltage drop $U_d$	≤ 2 V <sup>1)</sup>											
Power consumption	≤ 10 mA <sup>2)</sup>											
<b>Continuous current <math>I_a</math></b>	≤ 200 mA											
Time delay before availability $t_v$	≤ 100 ms											
Hysteresis H, of $s_r$	5 ... 15 %											
Repeatability R	≤ 2 % ( $U_b$ and $T_a$ constant) <sup>3)</sup>											
Temperature drift, of $s_r$	± 10 %											
EMC	According to EN 60947-5-2											
<b>Switching output</b>	NPN											
	PNP											
<b>Output function</b>	Normally closed											
	Normally open											
<b>Installation</b>	Flush											
<b>Connection type</b>	Connector, M12, 4-pin											
	Cable, PVC, 2 m											
<b>Enclosure rating</b>	IP 67 <sup>4)</sup>											
Max. switching frequency	300 Hz											
Dimensions	M18 x 1 <sup>5)</sup>											
<b>Short-circuit protection</b>	✓ <sup>6)</sup>											
<b>Reverse polarity protection</b>	✓											
<b>Power-up pulse suppression</b>	✓											
Shock/vibration stress	30 g, 11 ms/10 ... 55 Hz, 1 mm											
Ambient temperature $T_a$	-20 °C ... +65 °C											
<b>Housing material</b>	Brass nickel-plated, plastic											
Tightening torque	40 Nm											

<sup>1)</sup> at  $I_a$  max  
<sup>2)</sup> without load

<sup>3)</sup> of  $s_r$   
<sup>4)</sup> according to EN 60529

<sup>5)</sup> Thread diameter x pitch (mm)  
<sup>6)</sup> (pulsed)

**Reduction factor  $R_M$**

The following are reference values, which may vary from type to type:

St37 (Fe)	1
Stainless steel (V2A)	Approx. 0.8
Aluminum (solid)	Approx. 0.45
Copper (Cu)	Approx. 0.4

**Ordering information**

Type	Part Number
IME18-05BNOZC0K	1 040 945
IME18-05BNOZW2K	1 040 947
IME18-05BNSZC0K	1 040 941
IME18-05BNSZW2K	1 040 943
IME18-05BPOZC0K	1 040 937
IME18-05BPOZW2K	1 040 939
IME18-05BPSZC0K	1 040 933
IME18-05BPSZW2K	1 040 935

**Sensing range**  
8 mm

Inductive sensor

- Short-circuit protection (pulsed)
- Robust brass housing, nickel-plated with fine thread M18 x 1 mm
- Enclosure rating IP 67
- Installation non-flush

Dimensional drawing

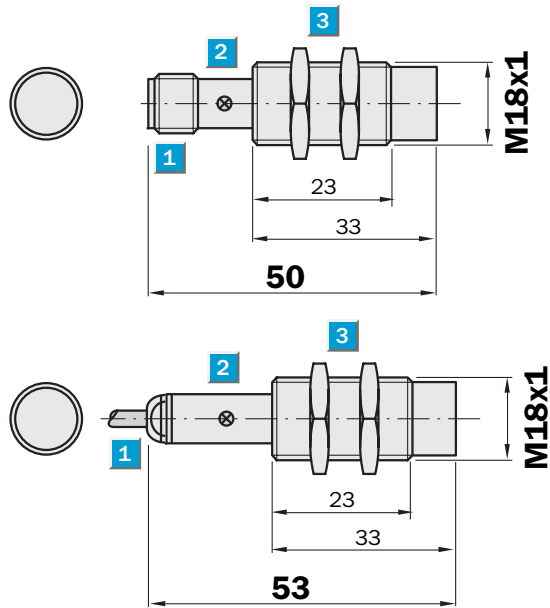

- 1 Connection
- 2 Display LED
- 3 Fastening nuts (2 x); width across 24, metal



Connection type

IME18-08NNOZCOK	IME18-08NNOZW2K	IME18-08NNSZCOK
IME18-08NPOZCOK	IME18-08NNSZW2K	IME18-08NPSZCOK
	IME18-08NPOSZW2K	
	IME18-08NPSZW2K	

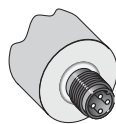

M12, 4-pin

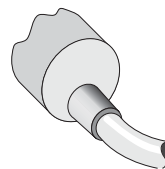
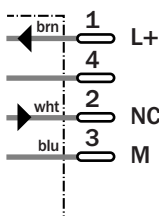

3 x 0.25 mm<sup>2</sup>

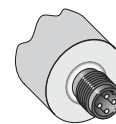
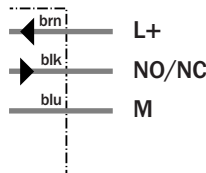

M12, 4-pin

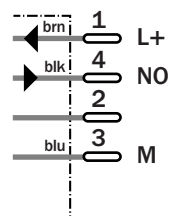

Accessories

- Connector, M12, 4-pin
- Mounting systems

Technical specifications		IME18-	08NN OZCOK	08NNO ZW2K	08NNS ZCOK	08NNS ZW2K	08NPO ZCOK	08NPO SZW2K	08NPS ZCOK	08NPS ZW2K		
<b>Sensing range <math>S_n</math></b>	8 mm											
<b>Electrical configuration</b>	DC 3-wire											
<b>Supply voltage <math>V_s</math></b>	DC 10 ... 30 V											
Nominal voltage $V_n$	DC											
Ripple $U_{pp}$	≤ 10 %											
Voltage drop $U_d$	≤ 2 V <sup>1)</sup>											
Power consumption	≤ 10 mA <sup>2)</sup>											
<b>Continuous current <math>I_a</math></b>	≤ 200 mA											
Time delay before availability $t_v$	≤ 100 ms											
Hysteresis H, of $s_r$	5 ... 15 %											
Repeatability R	≤ 2 % ( $U_b$ and $T_a$ constant) <sup>3)</sup>											
Temperature drift, of $s_r$	± 10 %											
EMC	According to EN 60947-5-2											
<b>Switching output</b>	NPN											
	PNP											
<b>Output function</b>	Normally closed											
	Normally open											
<b>Installation</b>	Non-flush											
<b>Connection type</b>	Connector, M12, 4-pin											
	Cable, PVC, 2 m											
<b>Enclosure rating</b>	IP 67 <sup>4)</sup>											
Max. switching frequency	300 Hz											
Dimensions	M18 x 1 <sup>5)</sup>											
<b>Short-circuit protection</b>	✓ <sup>6)</sup>											
<b>Reverse polarity protection</b>	✓											
<b>Power-up pulse suppression</b>	✓											
Shock/vibration stress	30 g, 11 ms/10 ... 55 Hz, 1 mm											
Ambient temperature $T_a$	-20 °C ... +65 °C											
<b>Housing material</b>	Brass nickel-plated, plastic											
Tightening torque	40 Nm											

<sup>1)</sup> at  $I_a$  max  
<sup>2)</sup> without load

<sup>3)</sup> of  $s_r$   
<sup>4)</sup> according to EN 60529

<sup>5)</sup> Thread diameter x pitch (mm)  
<sup>6)</sup> (pulsed)

**Reduction factor  $R_M$**

The following are reference values, which may vary from type to type:

St37 (Fe)	1
Stainless steel (V2A)	Approx. 0.8
Aluminum (solid)	Approx. 0.45
Copper (Cu)	Approx. 0.4

**Ordering information**

Type	Part Number
IME18-08NNOZCOK	1 040 961
IME18-08NNOZW2K	1 040 963
IME18-08NNSZCOK	1 040 957
IME18-08NNSZW2K	1 040 959
IME18-08NPOZCOK	1 040 953
IME18-08NPOSZW2K	1 040 955
IME18-08NPSZCOK	1 040 949
IME18-08NPSZW2K	1 040 951



**Sensing range**  
8 mm

Inductive sensor

- Enhanced sensing range
- Short-circuit protection (pulsed)
- Robust brass housing, nickel-plated with fine thread M18 x 1 mm
- Enclosure rating IP 67
- Installation quasi flush

Dimensional drawing

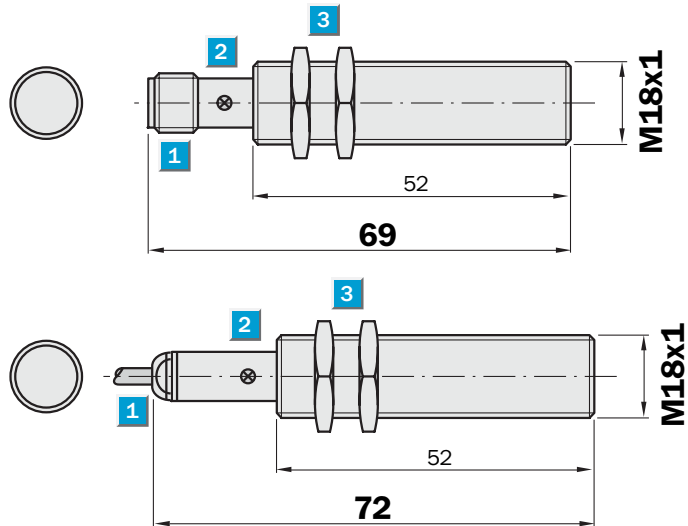

- 1 Connection
- 2 Display LED
- 3 Fastening nuts (2 x); width across 24, metal

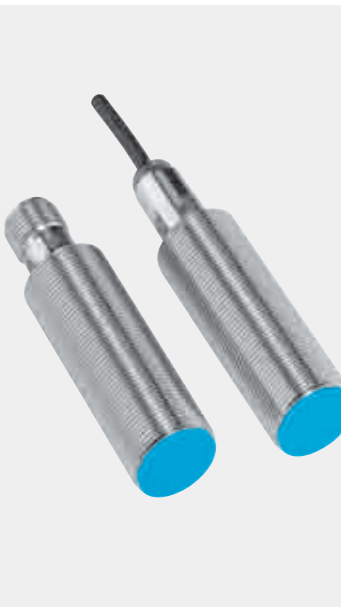

Connection type

IME18-BNOZCOS	IME18-08BNOZW2S	IME18-08BNSZCOS
IME18-08BPOZCOS	IME18-08BNSZW2S	IME18-08BPSZCOS
	IME18-08BPOZW2S	
	IME18-08BPSZW2S	

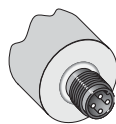

M12, 4-pin

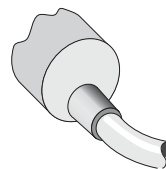
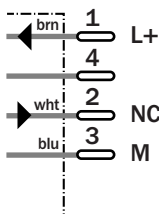

3 x 0.25 mm<sup>2</sup>

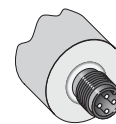
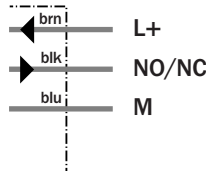

M12, 4-pin

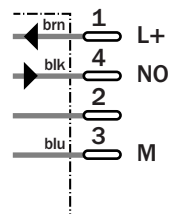

**Accessories**

Connector, M12, 4-pin

Mounting systems

Technical specifications		IME18-	BNOZC 0S	08BNO ZW2S	08BNS ZC0S	08BNS ZW2S	08BPO ZC0S	08BPO ZW2S	08BPS ZC0S	08BPS ZW2S		
<b>Sensing range <math>S_n</math></b>	8 mm											
<b>Electrical configuration</b>	DC 3-wire											
<b>Supply voltage <math>V_s</math></b>	DC 10 ... 30 V											
Nominal voltage $V_n$	DC											
Ripple $U_{pp}$	≤ 10 %											
Voltage drop $U_d$	≤ 2 V <sup>1)</sup>											
Power consumption	≤ 10 mA <sup>2)</sup>											
<b>Continuous current <math>I_a</math></b>	≤ 200 mA											
Time delay before availability $t_v$	≤ 100 ms											
Hysteresis H, of $s_r$	5 ... 15 %											
Repeatability R	≤ 2 % ( $U_b$ and $T_a$ constant) <sup>3)</sup>											
Temperature drift, of $s_r$	± 10 %											
EMC	According to EN 60947-5-2											
<b>Switching output</b>	NPN											
	PNP											
<b>Output function</b>	Normally closed											
	Normally open											
<b>Installation</b>	Quasi-flush											
<b>Connection type</b>	Connector, M12, 4-pin											
	Cable, PVC, 2 m											
<b>Enclosure rating</b>	IP 67 <sup>4)</sup>											
Max. switching frequency	300 Hz											
Dimensions	M18 x 1 <sup>5)</sup>											
<b>Short-circuit protection</b>	✓ <sup>6)</sup>											
<b>Reverse polarity protection</b>	✓											
<b>Power-up pulse suppression</b>	✓											
Shock/vibration stress	30 g, 11 ms/10 ... 55 Hz, 1 mm											
Ambient temperature $T_a$	-20 °C ... +65 °C											
<b>Housing material</b>	Brass nickel-plated, plastic											
Tightening torque	40 Nm											

<sup>1)</sup> at  $I_a$  max  
<sup>2)</sup> without load

<sup>3)</sup> of  $s_r$   
<sup>4)</sup> according to EN 60529

<sup>5)</sup> Thread diameter x pitch (mm)  
<sup>6)</sup> (pulsed)

**Reduction factor  $R_M$**

The following are reference values, which may vary from type to type:

St37 (Fe)	1
Stainless steel (V2A)	Approx. 0.8
Aluminum (solid)	Approx. 0.45
Copper (Cu)	Approx. 0.4

**Ordering information**

Type	Part Number
IME18-BNOZC0S	1 040 978
IME18-08BNOZW2S	1 040 980
IME18-08BNSZC0S	1 040 974
IME18-08BNSZW2S	1 040 976
IME18-08BPOZC0S	1 040 970
IME18-08BPOZW2S	1 040 972
IME18-08BPSZC0S	1 040 966
IME18-08BPSZW2S	1 040 968

**Sensing range**  
12 mm

Inductive sensor

- Short-circuit protection (pulsed)
- Robust brass housing, nickel-plated with fine thread M18 x 1 mm
- Enclosure rating IP 67
- Installation non-flush

Dimensional drawing

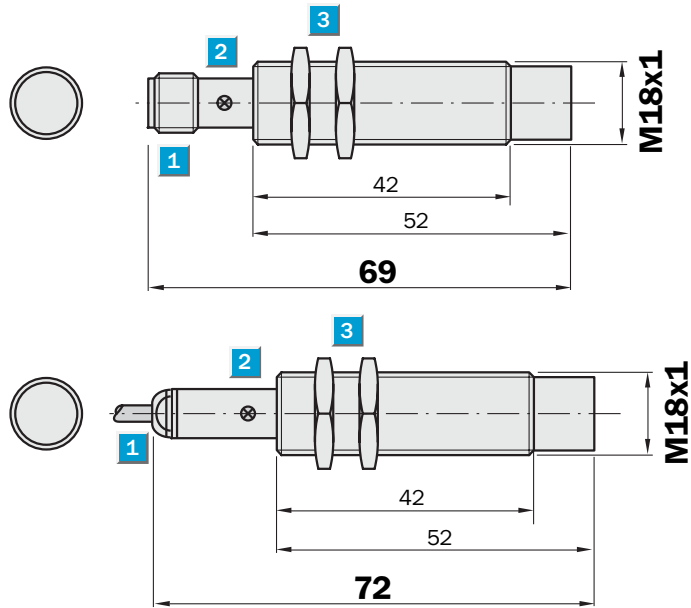

- 1 Connection
- 2 Display LED
- 3 Fastening nuts (2 x); width across 24, metal



Connection type

IME18-12NNOZC0S	IME18-12NNOZW2S	IME18-12NNSZC0S
IME18-12NPOZC0S	IME18-12NNSZW2S	IME18-12NPSZC0S
	IME18-12NPOZW2S	
	IME18-12NPSZW2S	

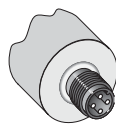

M12, 4-pin

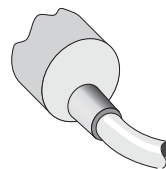
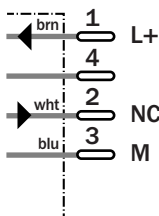

3 x 0.25 mm<sup>2</sup>

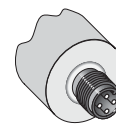
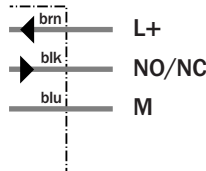

M12, 4-pin

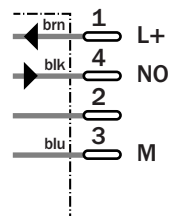

**Accessories**

Connector, M12, 4-pin

Mounting systems

Technical specifications		IME18-	12NN OZC0S	12NNO ZW2S	12NNS ZC0S	12NNS ZW2S	12NPO ZC0S	12NPO ZW2S	12NPS ZC0S	12NPS ZW2S		
<b>Sensing range <math>S_n</math></b>	12 mm											
<b>Electrical configuration</b>	DC 3-wire											
<b>Supply voltage <math>V_s</math></b>	DC 10 ... 30 V											
Nominal voltage $V_n$	DC											
Ripple $U_{pp}$	≤ 10 %											
Voltage drop $U_d$	≤ 2 V <sup>1)</sup>											
Power consumption	≤ 10 mA <sup>2)</sup>											
<b>Continuous current <math>I_a</math></b>	≤ 200 mA											
Time delay before availability $t_v$	≤ 100 ms											
Hysteresis H, of $s_r$	5 ... 15 %											
Repeatability R	≤ 2 % ( $U_b$ and $T_a$ constant) <sup>3)</sup>											
Temperature drift, of $s_r$	± 10 %											
EMC	According to EN 60947-5-2											
<b>Switching output</b>	NPN											
	PNP											
<b>Output function</b>	Normally closed											
	Normally open											
<b>Installation</b>	Non-flush											
<b>Connection type</b>	Connector, M12, 4-pin											
	Cable, PVC, 2 m											
<b>Enclosure rating</b>	IP 67 <sup>4)</sup>											
Max. switching frequency	300 Hz											
Dimensions	M18 x 1 <sup>5)</sup>											
<b>Short-circuit protection</b>	✓ <sup>6)</sup>											
<b>Reverse polarity protection</b>	✓											
<b>Power-up pulse suppression</b>	✓											
Shock/vibration stress	30 g, 11 ms/10 ... 55 Hz, 1 mm											
Ambient temperature $T_a$	-20 °C ... +65 °C											
<b>Housing material</b>	Brass nickel-plated, plastic											
Tightening torque	40 Nm											

<sup>1)</sup> at  $I_a$  max  
<sup>2)</sup> without load

<sup>3)</sup> of  $s_r$   
<sup>4)</sup> according to EN 60529

<sup>5)</sup> Thread diameter x pitch (mm)  
<sup>6)</sup> (pulsed)

**Reduction factor  $R_M$**

The following are reference values, which may vary from type to type:

St37 (Fe)	1
Stainless steel (V2A)	Approx. 0.8
Aluminum (solid)	Approx. 0.45
Copper (Cu)	Approx. 0.4

**Ordering information**

Type	Part Number
IME18-12NNOZC0S	1 040 994
IME18-12NNOZW2S	1 040 996
IME18-12NNSZC0S	1 040 990
IME18-12NNSZW2S	1 040 992
IME18-12NPOZC0S	1 040 986
IME18-12NPOZW2S	1 040 988
IME18-12NPSZC0S	1 040 982
IME18-12NPSZW2S	1 040 984

**Sensing range**  
8 mm

Inductive sensor

- Enhanced sensing range
- Short-circuit protection (pulsed)
- Robust brass housing, nickel-plated with fine thread M18 x 1 mm
- Enclosure rating IP 67
- Installation quasi flush

Dimensional drawing

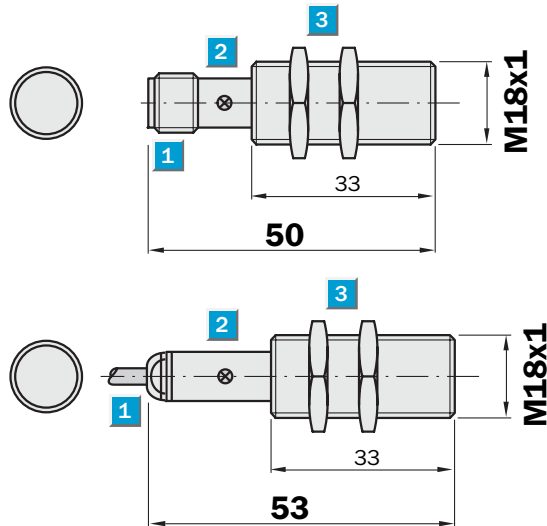

- 1 Connection
- 2 Display LED
- 3 Fastening nuts (2 x); width across 24, metal



Connection type

IME18-08BNOZCOK	IME18-08BNOZW2K	IME18-08BNSZCOK
IME18-08BPOZCOK	IME18-08BNSZW2K	IME18-08BPSZCOK
	IME18-08BPOZW2K	
	IME18-08BPSZW2K	

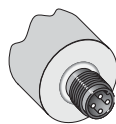

M12, 4-pin

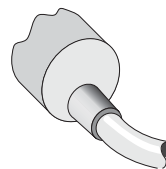
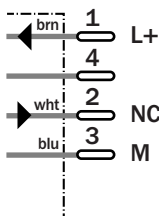

3 x 0.25 mm<sup>2</sup>

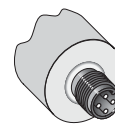
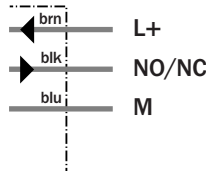

M12, 4-pin

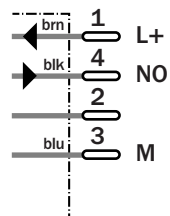

**Accessories**

Connector, M12, 4-pin

Mounting systems

Technical specifications		IME18-	08BNO ZCOK	08BNO ZW2K	08BNS ZCOK	08BNS ZW2K	08BPO ZCOK	08BPO ZW2K	08BPS ZCOK	08BPS ZW2K		
<b>Sensing range <math>S_n</math></b>	8 mm											
<b>Electrical configuration</b>	DC 3-wire											
<b>Supply voltage <math>V_s</math></b>	DC 10 ... 30 V											
Nominal voltage $V_n$	DC											
Ripple $U_{pp}$	≤ 10 %											
Voltage drop $U_d$	≤ 2 V <sup>1)</sup>											
Power consumption	≤ 10 mA <sup>2)</sup>											
<b>Continuous current <math>I_a</math></b>	≤ 200 mA											
Time delay before availability $t_v$	≤ 100 ms											
Hysteresis H, of $s_r$	5 ... 15 %											
Repeatability R	≤ 2 % ( $U_b$ and $T_a$ constant) <sup>3)</sup>											
Temperature drift, of $s_r$	± 10 %											
EMC	According to EN 60947-5-2											
<b>Switching output</b>	NPN											
	PNP											
<b>Output function</b>	Normally closed											
	Normally open											
<b>Installation</b>	Quasi-flush											
<b>Connection type</b>	Connector, M12, 4-pin											
	Cable, PVC, 2 m											
<b>Enclosure rating</b>	IP 67 <sup>4)</sup>											
Max. switching frequency	300 Hz											
Dimensions	M18 x 1 <sup>5)</sup>											
<b>Short-circuit protection</b>	✓ <sup>6)</sup>											
<b>Reverse polarity protection</b>	✓											
<b>Power-up pulse suppression</b>	✓											
Shock/vibration stress	30 g, 11 ms/10 ... 55 Hz, 1 mm											
Ambient temperature $T_a$	-20 °C ... +65 °C											
<b>Housing material</b>	Brass nickel-plated, plastic											
Tightening torque	40 Nm											

<sup>1)</sup> at  $I_a$  max  
<sup>2)</sup> without load

<sup>3)</sup> of  $s_r$   
<sup>4)</sup> according to EN 60529

<sup>5)</sup> Thread diameter x pitch (mm)  
<sup>6)</sup> (pulsed)

**Reduction factor  $R_M$**

The following are reference values, which may vary from type to type:

St37 (Fe)	1
Stainless steel (V2A)	Approx. 0.8
Aluminum (solid)	Approx. 0.45
Copper (Cu)	Approx. 0.4

**Ordering information**

Type	Part Number
IME18-08BNOZCOK	1 040 977
IME18-08BNOZW2K	1 040 979
IME18-08BNSZCOK	1 040 973
IME18-08BNSZW2K	1 040 975
IME18-08BPOZCOK	1 040 969
IME18-08BPOZW2K	1 040 971
IME18-08BPSZCOK	1 040 965
IME18-08BPSZW2K	1 040 967

**Sensing range**  
12 mm

Inductive sensor

- Short-circuit protection (pulsed)
- Robust brass housing, nickel-plated with fine thread M18 x 1 mm
- Enclosure rating IP 67
- Installation non-flush

Dimensional drawing

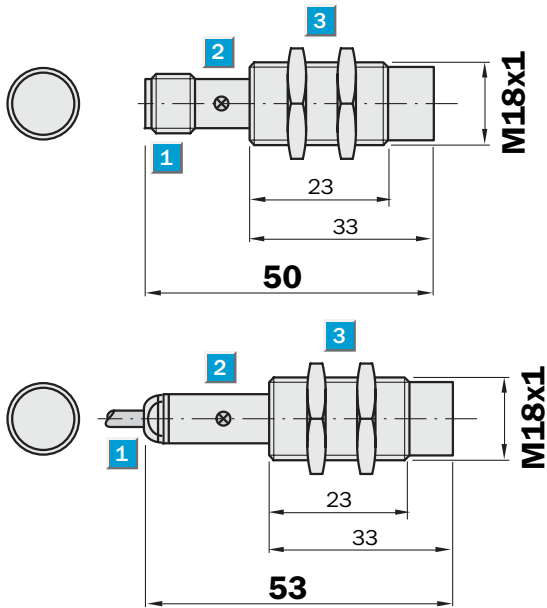

- 1 Connection
- 2 Display LED
- 3 Fastening nuts (2 x); width across 24, metal



Connection type

IME18-12NNOZCOK	IME18-12NNOZW2K	IME18-NNSZCOK
IME18-12NPOZCOK	IME18-12NNSZW2K	IME18-12NPSZCOK
	IME18-12NPOZW2K	
	IME18-12NPSZW2K	

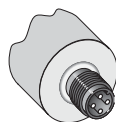

M12, 4-pin

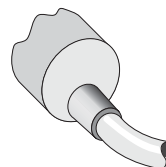
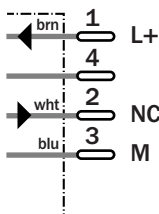

3 x 0.25 mm<sup>2</sup>

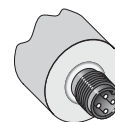
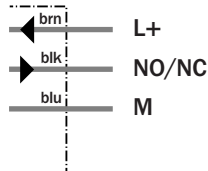

M12, 4-pin

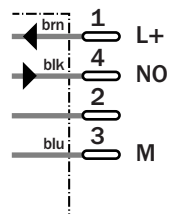

**Accessories**

Connector, M12, 4-pin

Mounting systems

Technical specifications		IME18-	12NN OZCOK	12NNO ZW2K	NNSZ COK	12NNS ZW2K	12NPO ZCOK	12NPO ZW2K	12NPS ZCOK	12NPS ZW2K		
<b>Sensing range <math>S_n</math></b>	12 mm											
<b>Electrical configuration</b>	DC 3-wire											
<b>Supply voltage <math>V_s</math></b>	DC 10 ... 30 V											
Nominal voltage $V_n$	DC											
Ripple $U_{pp}$	≤ 10 %											
Voltage drop $U_d$	≤ 2 V <sup>1)</sup>											
Power consumption	≤ 10 mA <sup>2)</sup>											
<b>Continuous current <math>I_a</math></b>	≤ 200 mA											
Time delay before availability $t_v$	≤ 100 ms											
Hysteresis H, of $s_r$	5 ... 15 %											
Repeatability R	≤ 2 % ( $U_b$ and $T_a$ constant) <sup>3)</sup>											
Temperature drift, of $s_r$	± 10 %											
EMC	According to EN 60947-5-2											
<b>Switching output</b>	NPN											
	PNP											
<b>Output function</b>	Normally closed											
	Normally open											
<b>Installation</b>	Non-flush											
<b>Connection type</b>	Connector, M12, 4-pin											
	Cable, PVC, 2 m											
<b>Enclosure rating</b>	IP 67 <sup>4)</sup>											
Max. switching frequency	300 Hz											
Dimensions	M18 x 1 <sup>5)</sup>											
<b>Short-circuit protection</b>	✓ <sup>6)</sup>											
<b>Reverse polarity protection</b>	✓											
<b>Power-up pulse suppression</b>	✓											
Shock/vibration stress	30 g, 11 ms/10 ... 55 Hz, 1 mm											
Ambient temperature $T_a$	-20 °C ... +65 °C											
<b>Housing material</b>	Brass nickel-plated, plastic											
Tightening torque	40 Nm											

<sup>1)</sup> at  $I_a$  max  
<sup>2)</sup> without load

<sup>3)</sup> of  $s_r$   
<sup>4)</sup> according to EN 60529

<sup>5)</sup> Thread diameter x pitch (mm)  
<sup>6)</sup> (pulsed)

**Reduction factor  $R_M$**

The following are reference values, which may vary from type to type:

St37 (Fe)	1
Stainless steel (V2A)	Approx. 0.8
Aluminum (solid)	Approx. 0.45
Copper (Cu)	Approx. 0.4

**Ordering information**

Type	Part Number
IME18-12NNOZCOK	1 040 993
IME18-12NNOZW2K	1 040 995
IME18-NNSZCOK	1 040 989
IME18-12NNSZW2K	1 040 991
IME18-12NPOZCOK	1 040 985
IME18-12NPOZW2K	1 040 987
IME18-12NPSZCOK	1 040 981
IME18-12NPSZW2K	1 040 983